

Company Profile



Transient Voltage Protection Systems Pvt Ltd

D-16 Meera Marg, Bani Park, Jaipur – 302016, India

Tel: 91 (141) 220 0284, 220 1824 Fax: 91(141)220 1115 Email: info@punsumi.com

www.punsumi.com

Introduction

Managing Director	Puneet Bhargava Bachelor of Science: VLSI design, 1992, University of Minnesota, USA Master of Business Administration: Finance, 1995, University of Minnesota, USA
Office	D-16 Meera Marg, Bani Park, Jaipur – 302016, India Office Area: 4000 Square Ft Employees: 12
Factory	325 Harnathpura, Niwaru Road, Jhotwara, Jaipur – 302012, India Constructed Area: 20000 Square Ft Employees: 97

Brief History

- Setup in 2001
- Acquisition of Punsumi Devices in 2003
- Technology provided by Japanese Scientist/Inventor
- Global Patents
- UL Recognized components (File no. E 300611)
- World class Manufacturing facility
- Well equipped R&D lab
- Well known **PUNSUMI** brand
- Supplier to LG since November 2003

LG – Approvals

Part Description	Punsumi Part Code	LG Part Code
Spark Gap – DO-41, 310V	PTB 311M	6918VAX002J
Spark Gap – DO-41, 1000V	PTHC 102M	69189RA001A
Spark Gap – DO-41, 1200V	PTHC 122M	
Spark Gap – DO-41, 1500V	PTHC 152M	164-004A
Spark Gap – DO-41L, 3600V	PTHC 362M	
Power Line Module – AC	PLM BZR 701M	164-003N
Power Line Module – DC	PLM BXT 501M	
Aluminum Electrolytic Capacitor	PSS 220 μ F, 500V	

Products

- Surge Protective Devices
 - Spark Gaps
 - Hybrid Surge Protection Modules
- Aluminum Electrolytic Capacitors
 - Snap-in
 - Lug-Terminal
 - Screw Terminal
- Zener Diodes

Products - Surge Protective Devices

■ Spark Gaps

- Low Voltage Silicon Chip Spark Gaps - PSA Series
- High Voltage Ceramic Spark Gaps - PTHC Series

■ Hybrid Surge Protection Modules

- Power Line Modules
 - AC lines - PLM BZR Series
 - DC Lines - PLM BXT Series
- High Voltage Modules
 - AC Lines - HVM BZR Series

Products – PSA

■ Punsumi Surge Absorbers (PSA)

- Low Voltage Spark Gaps
 - PTA Series (DO-35)
 - PTB Series (DO-41)
 - PTC Series (DO-37)
- High Voltage Ceramic Spark Gaps
 - PTHC Series (DO-41, DO-41S)

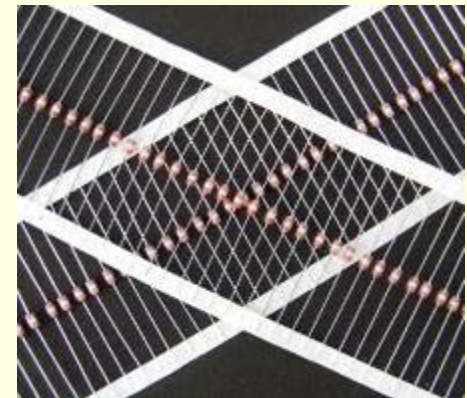
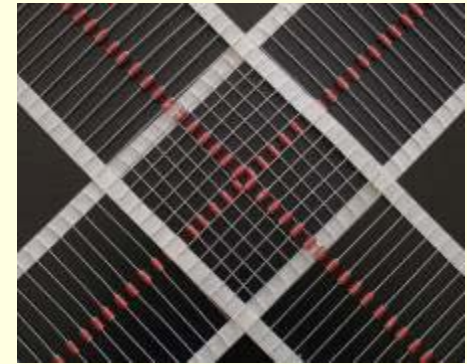

Products - PSA Applications

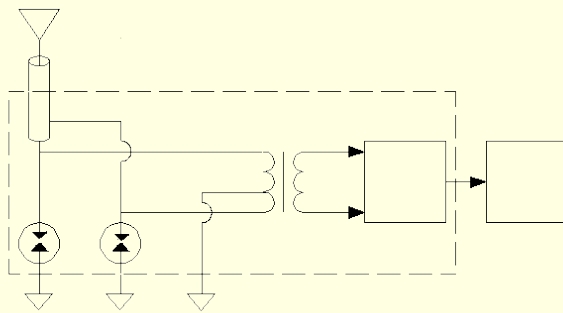

Antenna

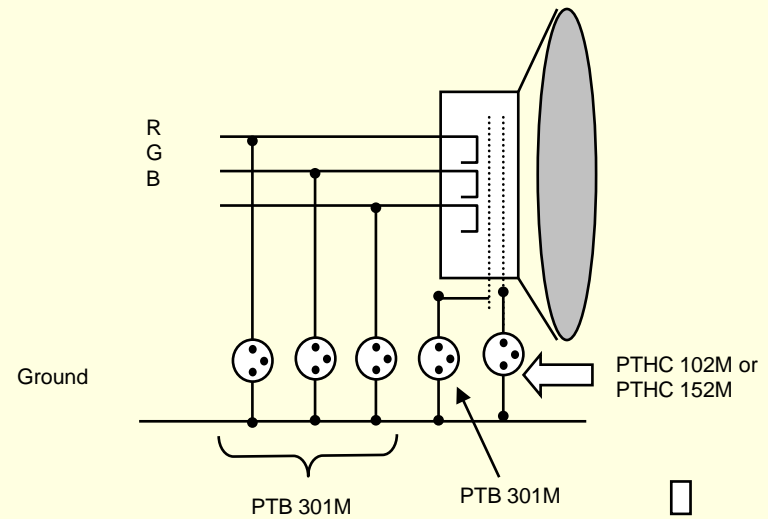







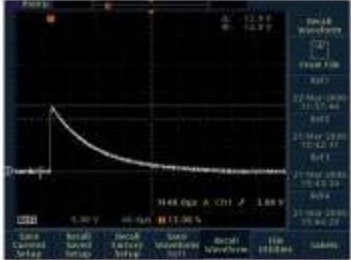

CRT

Products –PSA Selection Guide

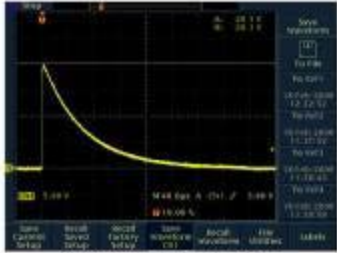
Model		DC Spark-over Voltage Vs (in Volts)	Insulation Resistance	Capacitance	Surge Life test			Surge Current Capacity		
PTA PTB PTC	201M	160-240	> 100 MΩ @ 100VDC	< 1pF	PTA	PTB	PTC	PTA	PTB	PTC
	251M	200-300			8x20μs, 100A, 1 min. interval, 50 times 1000pF, 10KV, 0Ω, 100 times, each interval is 10 sec.	8x20μs, 100A, 30 sec interval, 300 times	8x20μs, 100A, 30 sec interval, 200 times 1000pF, 10KV, 0Ω, 100 times, each interval is 10 sec.	8x20μs, 500A 3 times, 5min. interval	8x20μs, 1.5 kA, 3 times, 5min. interval	8x20μs, 1 kA, 3 times, 5min. interval
	301L	255-345								
	311M	260-370								
	301M	240-360								
PTB PTC	351N	245-455	> 100 MΩ @ 250VDC							
	401M	320-480								
	501M	400-600								
PTHC	102M	800-1200	> 100 MΩ @ 500VDC	< 1pF	8x20μs, 100A, 1 min. interval, 200 times			8x20μs, 500A		
	152M	1200-1800								
	242M	1900-2900								
	302M	2400-3600								
	362M	2800-4300								

Products – PSA Performance

 <p>1.2/50-1200 Volt waveform</p>	 <p>PTB1 response of Punsumi PTB 311M Peak Voltage: 380V</p>	 <p>SMART1 Response of Smart Electronics SSG 351N Peak Voltage: 460V</p>	 <p>MITSUBISHI-1 response of Mitsubishi DSS 301M Peak Voltage: 470V</p>
 <p>ORIGINAL 2000V WAVEFORM</p>	 <p>PTB-4, 2KV Response of Punsumi PTB 311M Peak Voltage: 670V</p>	 <p>SMART-1, 2KV Response of Smart Electronics SSG 351N Peak Voltage: 750V</p>	 <p>MITSUBISHI-1, 2KV Response of Mitsubishi DSS 301M Peak Voltage: 730V</p>

Products – Hybrid Surge Protection Modules

■ Power Line Modules (PLM)

- AC Lines
 - PLM BZR
 - PLM CZR
 - PLM DZR

- DC Lines
 - PLM BXT

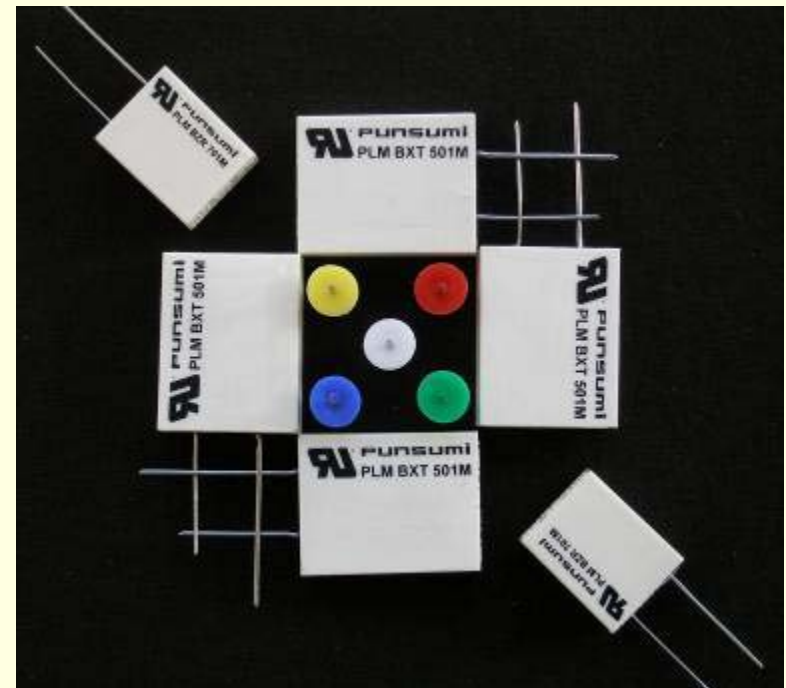

Products- PLM BZR Applications

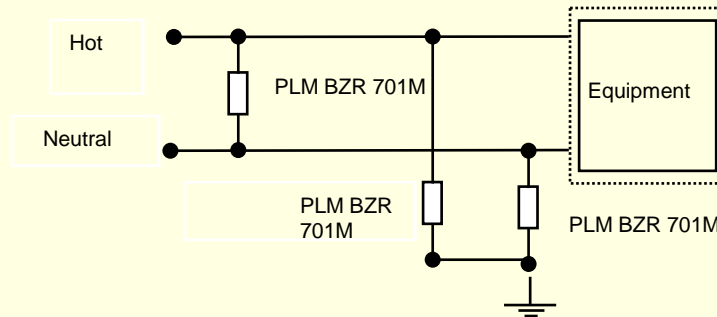

Products – PLM Selection Guide

■ FOR AC Lines

Model		DC Spark-over Voltage Vs (in Volts)	Insulation Resistance	Clamping Voltage @ 50A	Surge Life test	Surge Current Capacity	AC withstand voltage	Capacitance	Suggested Application AC input
PLM BZR	301L	255-345	> 100 MΩ @ 100VDC	275 V	8x20μs, 100A, 30sec, 500 times	8x20μs, 5 min. 3kA, 3 times	140 V	<2pF	110 V rms
	401M	320-480		275 V			175 V		110 V rms
	501M	400-600		500 V			250 V		170 V rms
	601M	480-720	> 100 MΩ @ 250VDC	600 V			275 V		240 V rms
	701M	560-840		750 V			330 V		240 V rms
	102M	800-1200		850 V			500 V		415 V rms
PLM CZR	501M	400-600	> 100 MΩ @ 100VDC	500 V	8x20μs, 100A, 30sec, 300 times	8x20μs, 5 min. 2kA, 3 times	275 V	<2pF	170 V rms
	701M	560-840	> 100 MΩ @ 250VDC	750 V			330 V		240 V rms
PLM DZR	501M	400-600	> 100 MΩ @ 100VDC	500 V	8x20μs, 100A, 30sec, 200 times	8x20μs, 5 min. 1kA, 3 times	275 V	<2Pf	170 V rms
	701M	560-840	> 100 MΩ @ 250VDC	750 V			330 V		240 V rms

Products – PLM BZR Performance



8/20-3000Amp PLM701M v/s MOV 510V AC



1.2/50-2000V PLM701M v/s MOV510 AC

Response of PLM BZR 701M on Current Surge 8x20ms, 3000A

- a) Waveform on Top: Original Short Circuit Waveform
- b) Waveform in Middle: Current Shunted by PLM
- c) Waveform on Bottom: Current shunted by MOV Siemens 511/14 E2

Response of PLM BZR 701M on Voltage Surge 1.2x50ms, 2000V

- a) Waveform on Top: Original Open Circuit Waveform
- b) Waveform in Middle: Clamping voltage on MOV Siemens 511/14 E2
- c) Waveform on Bottom: Clamping voltage of PLM

Products – PLM BXT Application

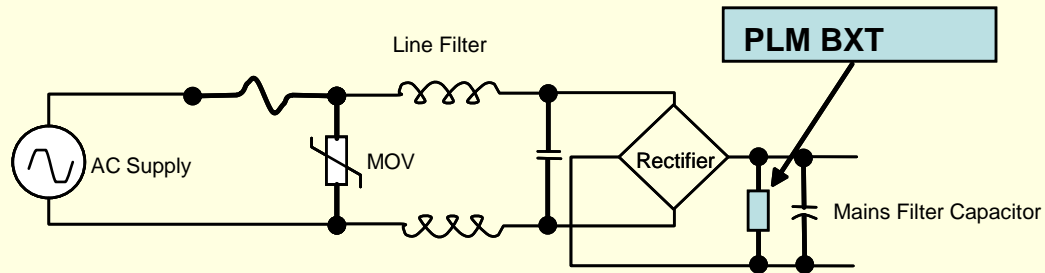

Products – PLM BXT Selection Guide

Model		DC Spark-over Voltage Vs (in Volts)	Insulation Resistance	Max Clamping Voltage	Surge Life test	Pulse Withstand Capability	Capacitance @ 1 K Hz
PLM BXT	451M	450 – 550V	> 100 MΩ @ 250VDC	450V	8x20μs, 100A, 30sec, 300 times	600V, 100ms pulses @ 1 min interval , 50 times in application	< 10 pF
	501M	500-600	> 100 MΩ @ 250VDC	560 V	8x20μs, 100A, 30sec, 300 times	650V, 100ms pulses @ 1 min interval , 50 times in application	< 5pF

Products – PLM BXT Performance



TDS 3034B - 2:03:39 PM 21-Jan-06

AC – input – Normal
220Vac with 600Vac, 100ms pulse



TDS 3034B - 3:16:35 PM 21-Jan-06

Sparking on MFC –
Without PLM BXT protection



TDS 3034B - 2:12:52 PM 21-Jan-06

Waveforms across MFC with
(Middle waveform) and without
(top waveform) PLM BXT
protection

Products – Aluminum Electrolytic Capacitors

- Snap – in Terminals
 - PSS Series – General Purpose
 - Load Life: 2000 hours at 85°C
 - Useful Life: 5000 hours at 85°C
 - Also available in reduced sizes (P2S & P3S Series)
 - PSX Series – Long Life
 - Load Life: 1000 hours at 105°C
 - Useful Life: 3000 hours at 105°C
 - Also available in reduced size (P2X Series)
 - PS4 Series – General Purpose, 4 Terminal
 - Load Life: 2000 hours at 85°C
 - Useful Life: 4000 hours at 85°C

Products – Aluminum Electrolytic Capacitors

■ Lug Terminal

■ PLG Series, General Purpose

- Load Life: 2000 hours at 85°C
- Useful Life: 4000 hours at 85°C

■ PLX Series, Long Life

- Load Life: 1000 hours at 105°C
- Useful Life: 3000 hours at 105°C

Products – Aluminum Electrolytic Capacitors

■ Screw Terminal

■ PCC Series: General Purpose

- Load Life: 2000 hours at 85°C
- Useful Life: 5000 hours at 85°C

■ PCX Series: Long Life

- Load Life: 1000 hours at 105°C
- Useful Life: 3000 hours at 105°C

Customers

LG Electronics	Spark Gaps, PLM	CTV, Monitor
Onida	Spark Gaps, PLM	CTV
Sanyo	PLM	CTV
BPL	PLM	CTV
D Link	Spark Gaps	Networking Equipment
GE	PLM	Electronic Ballasts
Others	PLM	CTV, Energy meters, Medical Equipment, Industrial Applications

Mission Statement

Build Punsumi into a global size, technology driven company, in the field of electronics, to serve the society and help India find its rightful place in the world arena.

Punsumi products and services should exceed customer expectations and provide optimum value for money.

Quality Policy Statement

Meet Customer Needs and develop and nurture Customer Trust through continuous upgradation and improvement in technology and productivity by providing R & D driven, reliable and cost-effective product offerings using industry global-best-practices.

Quality System

- Quality Manual
- Incoming Quality Inspection
- In-Process Inspection
- Final Inspection
- Pre-despatch Audit
- Standard Operating Procedures
- Work Instructions
- Quality Circles

Organization Chart

PUNSUMI

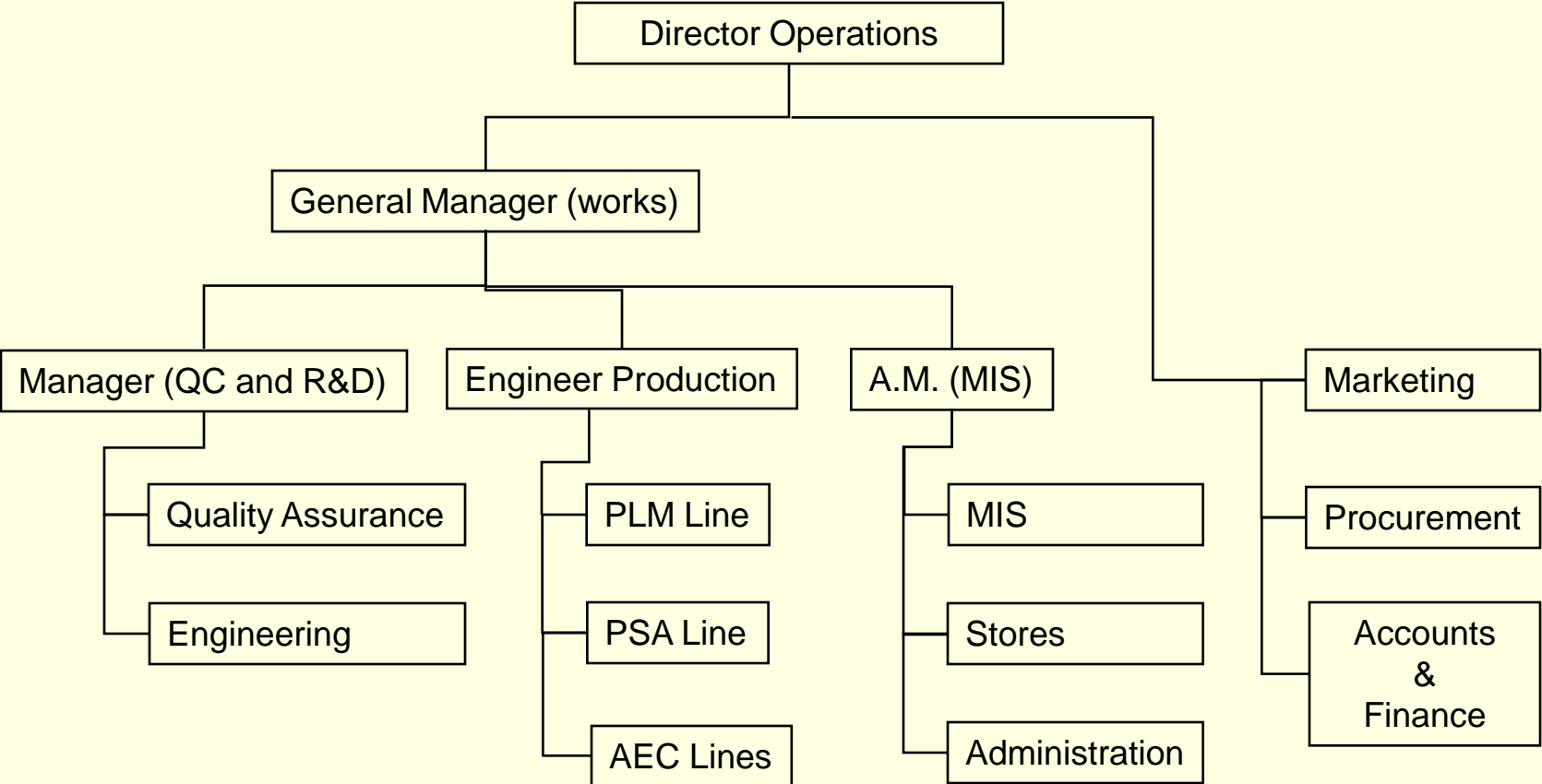

Snapshots - Factory



Snapshots – Assembly Room



Snapshots – Sealing Machines



Snapshots – Testing Line

PUNSUMI



Transient Voltage Protection Systems Pvt Ltd

Snapshots – R&D Lab

